

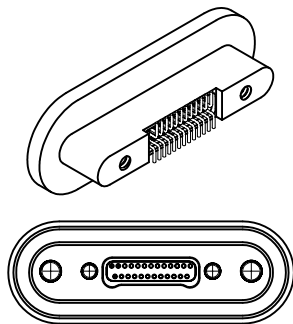

Recommended PC Board Layout

Vertical SMT Rcpt
FOR REFERENCE ONLY



CONNECTOR MATING FACE

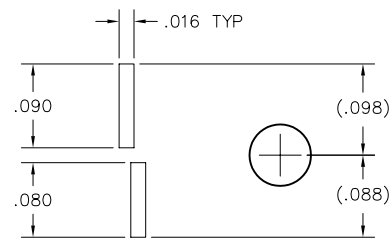

FOOTPRINT / PAD CONFIGURATION

9 POSITION

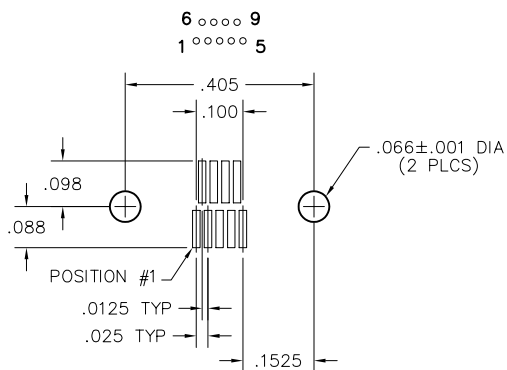

15 POSITION

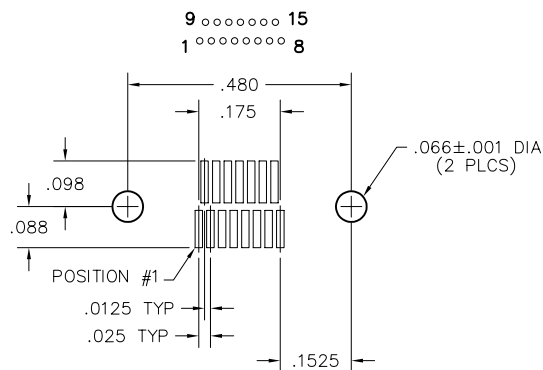

21 POSITION

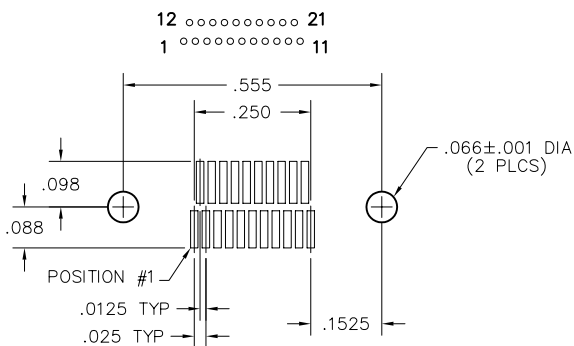

25 POSITION

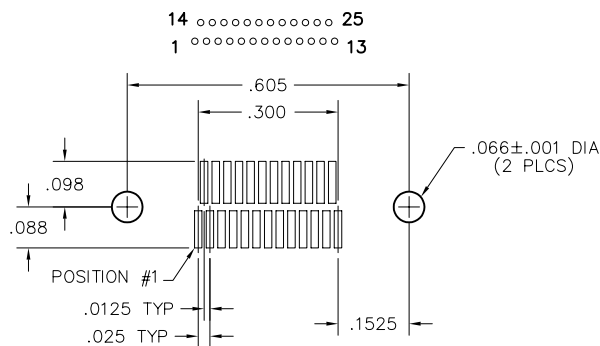

31 POSITION

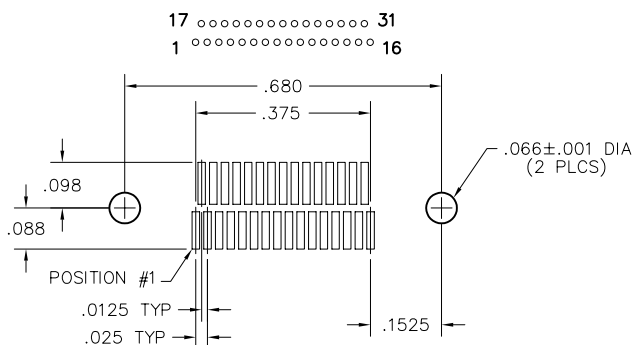

37 POSITION

