

MA-231-016-161-A64WS

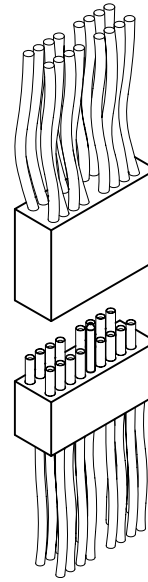

MA-241-016-261-A61WS

# 2 · ROW Strip Connectors Cable to Cable

.050"

**MA-2**

4 thru 128 Contacts

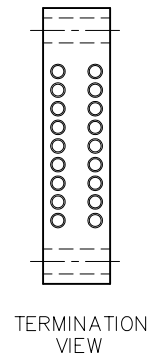
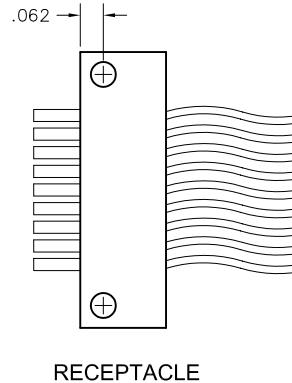
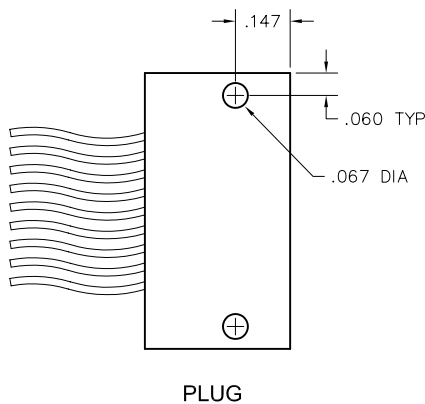
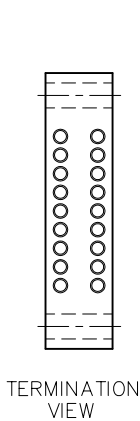
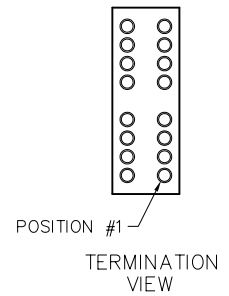
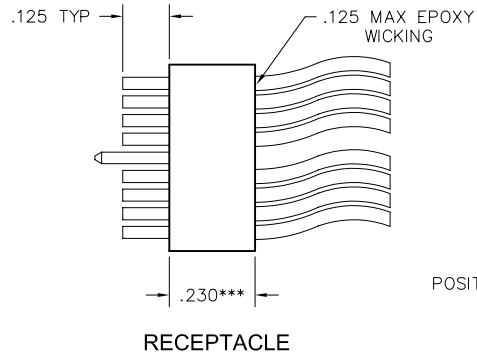
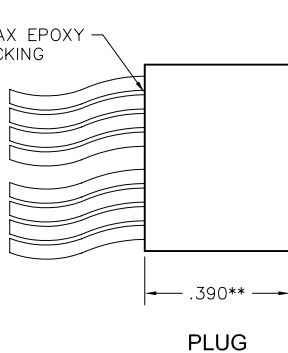
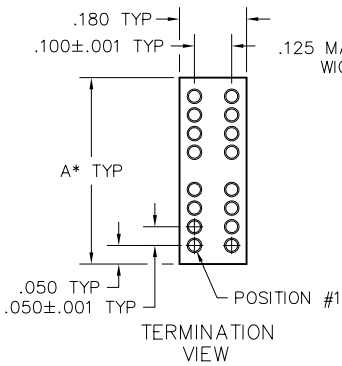

### OPTIONAL MOUNTING HOLES

DIMENSIONS	
To determine connector length (Dim "A"):	
Multiply the number of cavities in one row by .050"	. "
Add fixed end lengths (constant, .025" x 2)	<u>0.05"</u>
Add .085" for each mounting hole	. "
Total Length:	<u>. "</u>
<b>Notes:</b>	
Length over 2" may require support to insure alignment.	
* = Maximum length is 3.420". Maximum number of contacts must be reduced to accommodate hardware and mounting holes.	
** = For solder cup or board mount applications, .390" becomes .295"	
*** = For solder cup or board mount applications, .230" becomes .135"	